

Estimated Performance Curve

Sheet No.	
Customer	
Item No.	
Date	2017-03-07

SPECIFICATION

PUMP	Capacity	100 lpm at 65 m	MOTOR	OUTPUT	2.2KW
	Total Head	65 m		VOLTAGE	220/380V
	SUCTION BORE	30 mm		FREQUENCY	60Hz
	DISCHARGE BORE	25 mm		SPEED	3450rpm
	LIQUID	WATER		TYPE	TEFC
	MAKER	WILO		MAKER	WILO

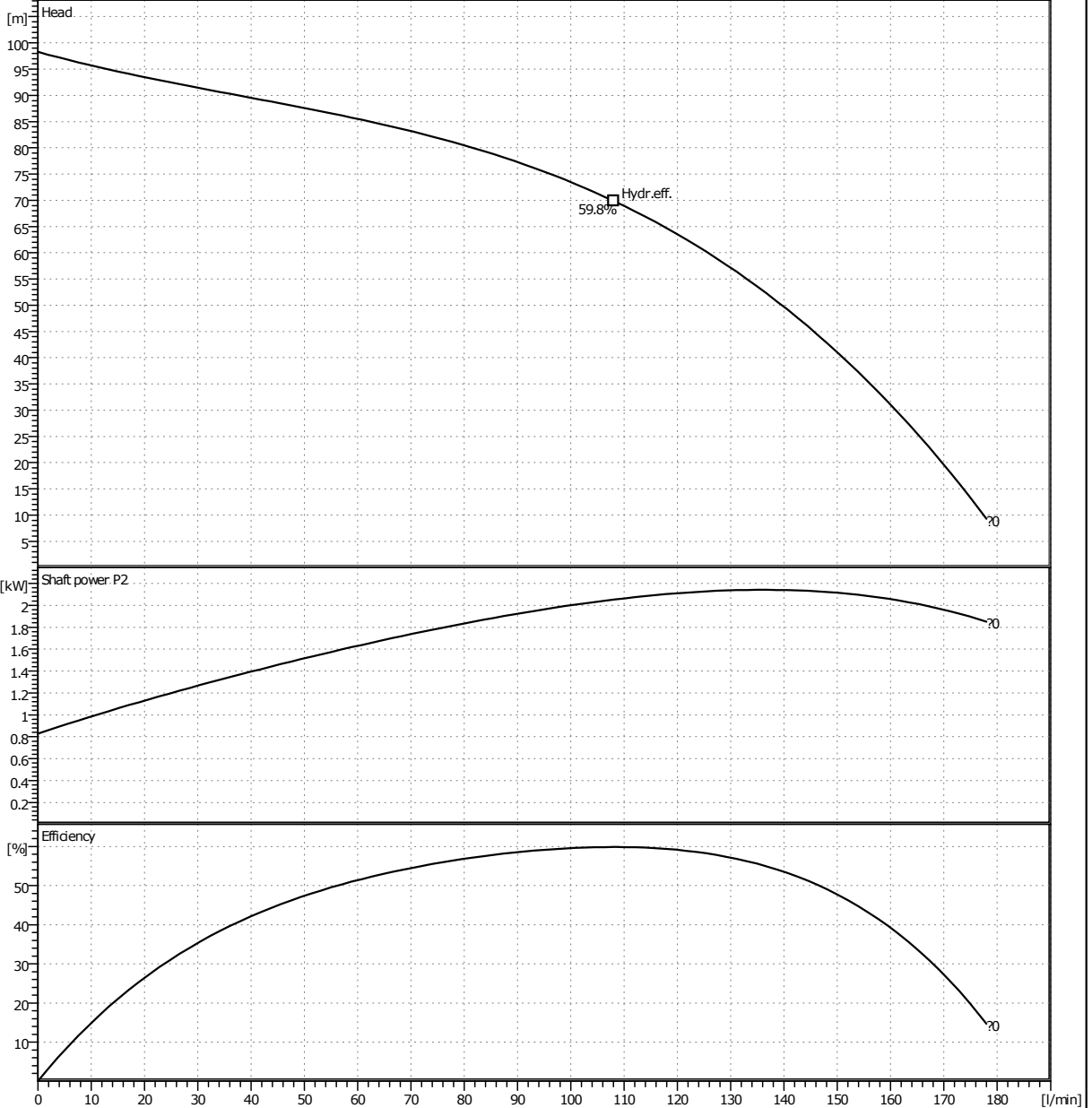

* Performance curve of some models is subject to have 10% deviation.

* Subject to change without prior notice.

TYPE	Horizontal Multi-stage
MODEL	MHI-406i
SERVICE	

Outline Drawing

Sheet No.	
Customer	
Item No.	
Date	2017-03-07

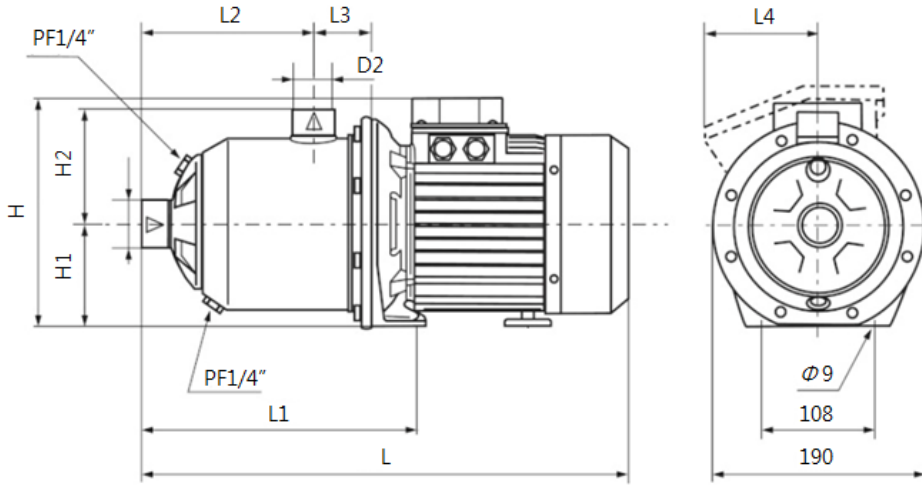

단위 : mm

Model	Power Source	H	H1	H2	L	L1	L2	L3	L4	D1	D2
MHI 402	M (1~, 220V, 60Hz)	200	90	104	354	204	109.5	51	106	30	25
MHI 403		200	90	104	380	204	109.5	51	106	30	25
MHI 404		228	90	104	428	252	157.5	51	120	30	25
MHI 402	I (3~, 220/380, 60Hz)	192	90	104	354	204	109.5	51	-	30	25
MHI 403		223	90	104	380	204	109.5	51	-	30	25
MHI 404		223	90	104	428	252	157.5	51	-	30	25
MHI 405	N (3~, 440V, 60Hz)	223	90	104	428	252	157.5	51	-	30	25
MHI 406		223	90	104	428	276	181.5	51	-	30	25

TYPE	Horizontal Multi-stage
MODEL	MHI-406i
SERVICE	