

wilo Pump Data Sheet

Sheet No.	
Customer	
Item No.	
Date	2017-02-27

1	MODEL	MVI 205 / PN16 / R		Title			
2	Location			Agent			
3	Service			Plant Name			
4	Quantity	Set(s)		Installation	<input checked="" type="checkbox"/> Indoor <input type="checkbox"/> Outdoor		
5	OPERATING CONDITION						
6	Liquid	Water		Flow	0 l/min		
7	Pumping Temp.	Ambient		Suc. Pressure			
8	S.G.	1		Dis. Pressure			
9	Vap. Pressure	0.03kg/cm2A at 24?		Diff. Pressure			
10	Viscosity	1 cP		Total Head	0 m		
11	PERFORMANCE AND CONSTRUCTION				MATERIAL		
12	Vertical	Efficiency			Part Name	Symbol	
13	No. of Stages	5	Rated Power			Casing	STS304
14	Speed	3550 rpm	NPSHre			Impeller	STS304
15	Rotation	CW (view from drive end)			Shaft	STS304	
16	BORE	Size(Dia)	Rating	Face	Position	Tube	STS304
17	Suction	25 mm	PN 16	RF	Side	Diffuser	STS304
18	Discharge	25 mm	PN 16	RF	Side	Top Cover	STS304
19	Impeller Type	Closed	Vertical Multi-Stage		HYDROSTATIC		
20	Flow Direction	Radial		Casing		3 min	
21	Shaft Seal	M/Seal	Shaft Sleeve	No	Jacket	3 min	
22	Mounting	Foot		TESTING			
23	Lubrication	<input checked="" type="checkbox"/> Grease		Items	Witness		
24	Cooling	<input checked="" type="checkbox"/> No Cooling		Run Perform.	<input checked="" type="checkbox"/> Yes <input type="checkbox"/> No	<input type="checkbox"/> Yes <input checked="" type="checkbox"/> No	
25	Radial Bearing	-	Thrust Bearing	-	Hydrostatic(Air Press.)	<input checked="" type="checkbox"/> Yes <input type="checkbox"/> No <input type="checkbox"/> Yes <input checked="" type="checkbox"/> No	
26	MOTOR SPECIFICATION				SPARE PART		
27	Supplier	WILO	Phase / V / Hz	3~ 380V ~ 60 Hz		Set(s)	
28	Type	TEFC	Furnished by	<input checked="" type="checkbox"/> WILO <input type="checkbox"/> Customer		Set(s)	
29	Power	1.5 kW	Mounted by	<input checked="" type="checkbox"/> WILO <input type="checkbox"/> Customer		Set(s)	
30	No. of Pole	2 P	Enclosure	<input checked="" type="checkbox"/> IP 55 <input type="checkbox"/>		Set(s)	
31	Insulation	<input checked="" type="checkbox"/> F <input type="checkbox"/>				Set(s)	
32	ACCESSORY(<input checked="" type="checkbox"/>Supplied : WILO)					Set(s)	
33	<input type="checkbox"/> Common Base					Set(s)	
34	<input type="checkbox"/> Foundation Bolts & Nuts					Set(s)	
35	<input checked="" type="checkbox"/> Coupling	Half (Rigid & Split Type)		<input checked="" type="checkbox"/> Coupling Guard		Set(s)	
36	<input type="checkbox"/> Pressure Guage					Set(s)	
37	<input checked="" type="checkbox"/> Plug for Drain & Air vent.					Set(s)	
38	<input type="checkbox"/> Seal Flushing					Set(s)	
39	M/Seal	Maker	Eagle-Burgmann	Model & Size	MG12	Set(s)	
40		Type	Unbalanced	Cooler	<input type="checkbox"/> Yes <input checked="" type="checkbox"/> No	Set(s)	
41		API 610 Plan			WEIGHT		
42	Material Code	SiC/Carbon,EPDM			Pump	29.5 kg	
43	<input type="checkbox"/> Companion Flanges						
44	<input type="checkbox"/> Special Tool						
					Total wt.	29.5 kg	

*Pump test acceptance grade in accordance with ISO 9906:2012, Grade 2B.

Estimated Performance Curve

Sheet No.	
Customer	
Item No.	
Date	2017-02-27

SPECIFICATION

PUMP		MOTOR	
CAPACITY	0 l/min	OUTPUT	1.5 kW
TOTAL HEAD	0 m	VOLTAGE	380V
SUCTION BORE	25 mm	FREQUENCY	60 Hz
DISCHARGE BORE	25 mm	SPEED	3550 1/min
LIQUID	WATER	TYPE	TEFC
MAKER	WILO	SUPPLIER	WILO

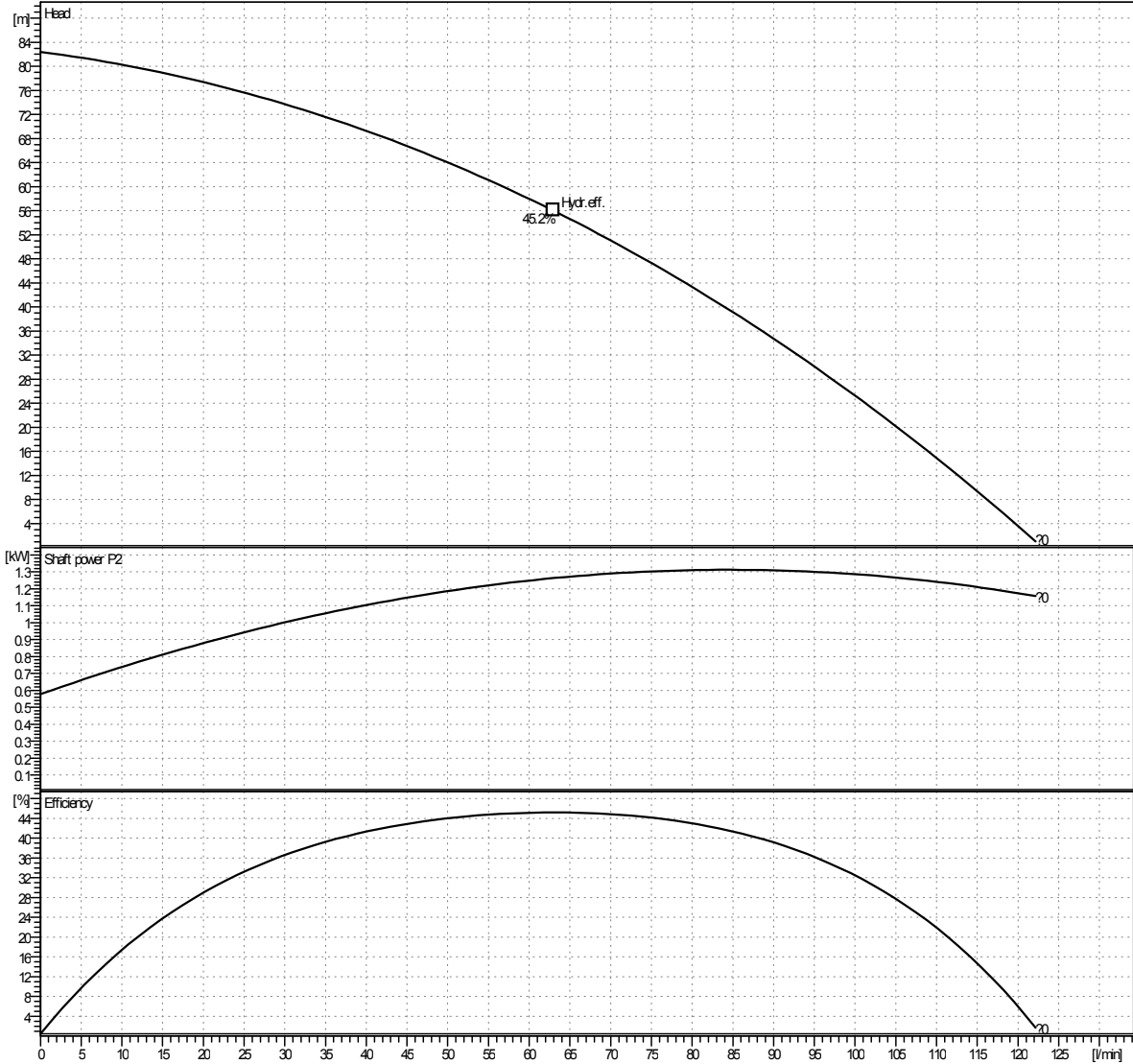

A/B Efficiency	Capacity	Efficiency(%)
A Efficiency	62.987 l/min	45.2
B Efficiency		

* Pump test acceptance grade in accordance with ISO 9906:2012, Grade 2B.

* Subject to change without prior notice.

TYPE	Vertical Multi-Stage
MODEL	MVI 205 / PN16 / R
SERVICE	

Outline Drawing

Sheet No.	
Customer	
Item No.	
Date	2017-02-27

SPECIFICATION

PUMP	CAPACITY	0 l/min	MOTOR	OUTPUT	1.5 kW
	TOTAL HEAD	0 m		VOLTAGE	380V
	SUCTION BORE	25 mm		FREQUENCY	60 Hz
	DISCHARGE BORE	25 mm		SPEED	3550 1/min
	LIQUID	WATER		TYPE	TEFC
	MAKER	WILO		SUPPLIER	WILO

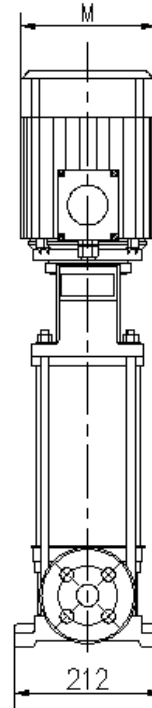
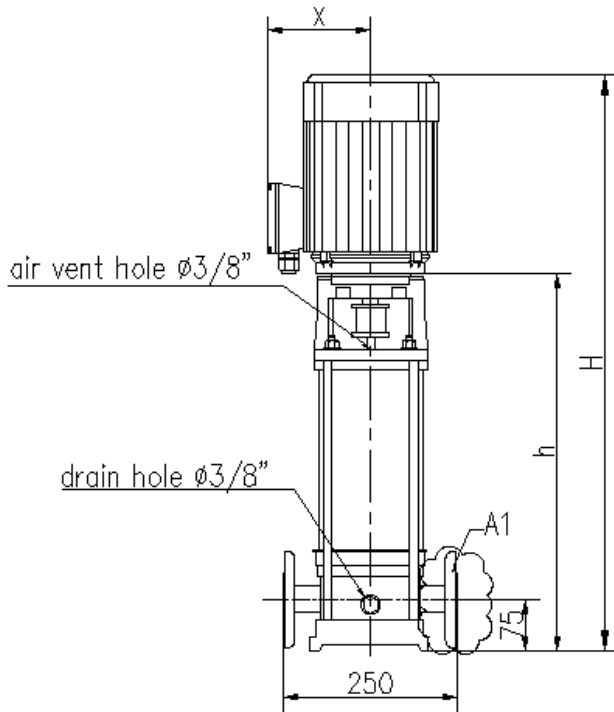
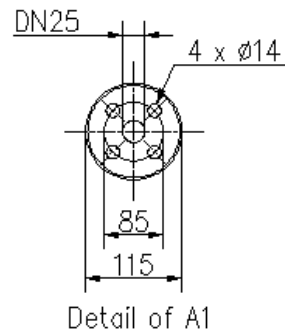
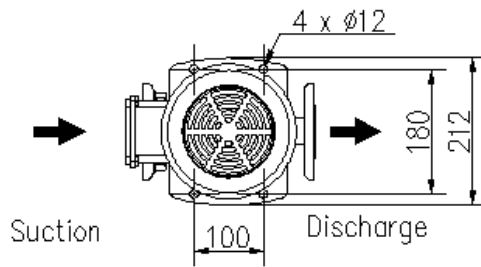

* Dimension of outline drawing subjects to change without prior notice.

h	390	H	649	M	170	X	134
---	-----	---	-----	---	-----	---	-----

TYPE	Vertical Multi-Stage
MODEL	MVI 205 / PN16 / R
SERVICE	

Sectional Drawing

Sheet No.	
Customer	
Item No.	
Date	2017-02-27

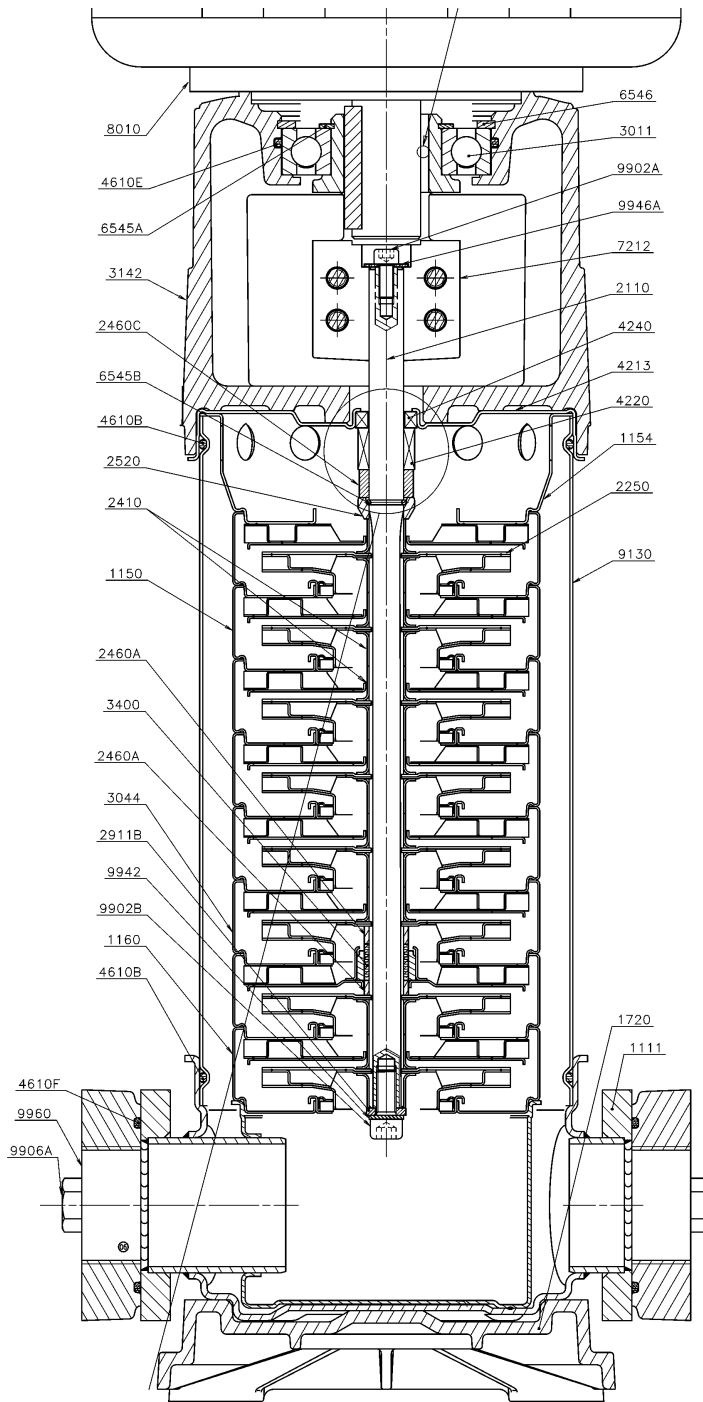

TYPE	Vertical Multi-Stage
MODEL	MVI 205 / PN16 / R
SERVICE	

Sectional Drawing

Sheet No.	
Customer	
Item No.	
Date	2017-02-27

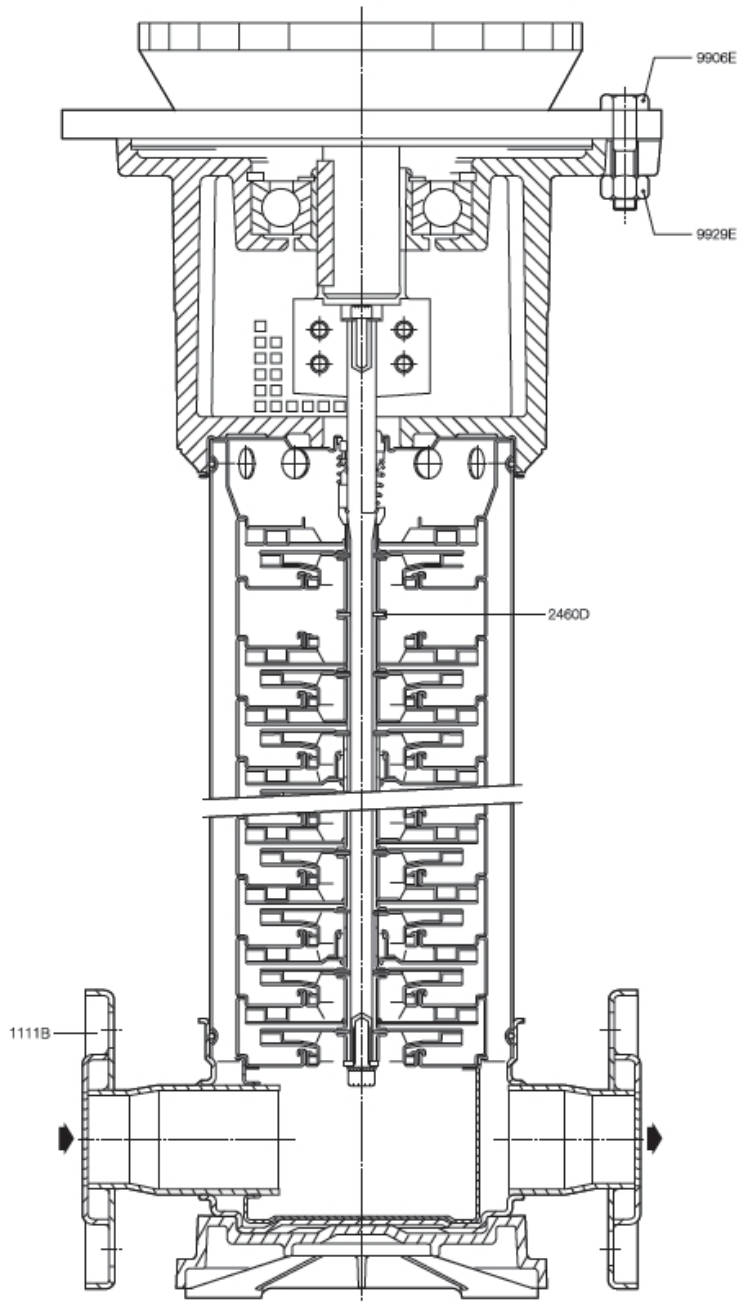

No	Description
1111	Pump Casing
1150	Stage casing with return channel
1154	Stage centering device
1160	Stage casing without return channel
1720	Pump fixing plate
2110	Pump shaft
2250	impeller
2410	impeller spacer
2460 A	Shaft sleeve adjustment spacer
2460 C	Mechanical seal keeper ring
2520	Back-up ring
2911B	Bottom shaft end washer
3011	Lantern ball bearing
3044	Stage casing with intermediate bearing
3142	Lantern
3400	Sleeve
4213	Stationary ring holder
4220	Rotating part - mechanical seal
4240	Stationary part - mechanical seal
4610 B	O-RING
4610 E	O-RING
4610 F	O-RING
6545 A	Circlip
6545 B	Half keeper
6546	Circlip
7212	Coupling
8010	Motor
9130	Tube
9902 A	Shaft end upper screw
9902 B	Shaft end lower screw
9906 A	Bolt
9942	Lock washer
9946 A	Washer
9960	Counter Flange

*PN 258bar Round Type은 Counter Flange 공급 불가

TYPE	Vertical Multi-Stage
MODEL	MVI 205 / PN16 / R
SERVICE	